

GaAlAs-Infrarot-Sendediode
GaAlAs-Infrared Emitter
Lead (Pb) Free Product - RoHS Compliant

IRL 81 A



Wesentliche Merkmale

- GaAlAs-Lumineszenzdiode im nahen Infrarotbereich
- Rosa Kunststoff-Miniaturgehäuse, seitliche Abstrahlung
- Preisgünstig
- Lange Lebensdauer (Langzeitstabilität)
- Weiter Öffnungskegel ($\pm 25^\circ$)
- Passend zu Fototransistor LPT 80 A

Anwendungen

- Fertigungs- und Kontrollanwendungen der Industrie, die eine Unterbrechung des Lichtstrahls erfordern
- Lichtschranken

Features

- GaAlAs infrared emitting diode in the near infrared range
- Pink plastic package with lateral emission
- Cost-effective
- Long-term stability
- Wide beam ($\pm 25^\circ$)
- Matches phototransistor LPT 80 A

Applications

- For a variety of manufacturing and monitoring applications which require beam interruption
- Light barriers

Typ Type	Bestellnummer Ordering Code	Gehäuse Package
IRL 81 A	Q68000A8000	Hellrot eingefärbtes Kunststoffgehäuse, seitliche Abstrahlung, Anschlüsse im 2,54 mm-Raster Light-red colored plastic package, sidelooker, solder tabs 2.54 mm ($\frac{1}{10}$ ")

Grenzwerte ($T_A = 25\text{ °C}$)**Maximum Ratings**

Bezeichnung Parameter	Symbol Symbol	Wert Value	Einheit Unit
Betriebs- und Lagertemperatur Operating and storage temperature range	$T_{op}; T_{stg}$	- 40 ... + 100	°C
Sperrspannung Reverse voltage	V_R	5	V
Durchlassstrom Forward current	I_F	100	mA
Verlustleistung Power dissipation	P_{tot}	200	mW
Wärmewiderstand Thermal resistance	R_{thJA}	375	K/W

Kennwerte ($T_A = 25\text{ °C}$)**Characteristics**

Bezeichnung Parameter	Symbol Symbol	Wert Value	Einheit Unit
Wellenlänge der Strahlung bei I_{max} Wavelength of peak emission	λ_{peak}	880	nm
Spektrale Bandbreite bei 50% von I_{max} Spectral bandwidth at 50% of I_{max}	$\Delta\lambda$	80	nm
Abstrahlwinkel Half angle	φ	± 25	Grad deg.
Aktive Chipfläche Active chip area	A	0.09	mm ²
Abmessungen der aktiven Chipfläche Dimension of the active chip area	$L \times B$ $L \times W$	0.3×0.3	mm ²
Schaltzeiten, I_e von 10% auf 90% und von 90% auf 10%, bei $I_F = 100\text{ mA}$, $R_L = 50\ \Omega$ Switching times, I_e from 10% to 90% and from 90% to 10%, $I_F = 100\text{ mA}$, $R_L = 50\ \Omega$	t_r, t_f	0.6/0.5	μs
Kapazität Capacitance $V_R = 0\text{ V}$, $f = 1\text{ MHz}$	C_o	15	pF
Durchlassspannung, $I_F = 20\text{ mA}$ Forward voltage	V_F	1.5 (≤ 2.0)	V

Kennwerte ($T_A = 25\text{ °C}$)

Characteristics (cont'd)

Bezeichnung Parameter	Symbol Symbol	Wert Value	Einheit Unit
Gesamtstrahlungsfluss, $I_F = 20\text{ mA}$ Total radiant flux	Φ_e	5	mW
Sperrstrom Reverse current $V_R = 5\text{ V}$	I_R	0.01 (≤ 1)	μA
Temperaturkoeffizient von I_e bzw. Φ_e , $I_F = 100\text{ mA}$ Temperature coefficient of I_e or Φ_e , $I_F = 100\text{ mA}$	TC_I	- 0.5	%/K
Temperaturkoeffizient von V_F , $I_F = 100\text{ mA}$ Temperature coefficient of V_F , $I_F = 100\text{ mA}$	TC_V	- 2	mV/K
Temperaturkoeffizient von λ , $I_F = 100\text{ mA}$ Temperature coefficient of λ , $I_F = 100\text{ mA}$	TC_λ	0.25	nm/K

Strahlstärke I_e in Achsrichtunggemessen bei einem Raumwinkel $\Omega = 0.01\text{ sr}$ **Radiant Intensity I_e in Axial Direction**at a solid angle of $\Omega = 0.01\text{ sr}$

Bezeichnung Parameter	Symbol	Werte Values	Einheit Unit
Strahlstärke Radiant intensity $I_F = 20\text{ mA}$, $t_p = 20\text{ ms}$	$I_{e\text{ min}}$ $I_{e\text{ typ}}$	1.0 2.5	mW/sr mW/sr

Relative Spectral Emission

$I_{rel} = f(\lambda)$

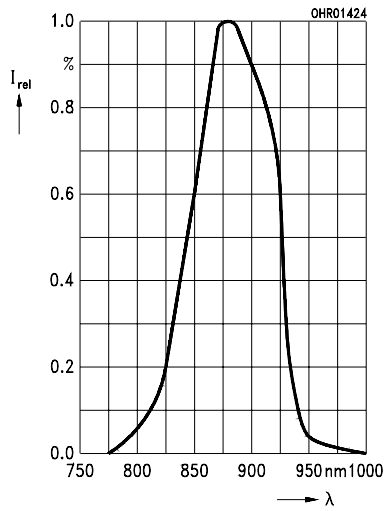

Max. Forward Current

$I_F = f(T_A)$

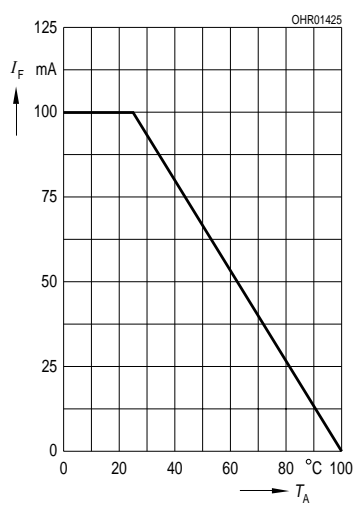

Forward Current

$I_F = f(V_F)$

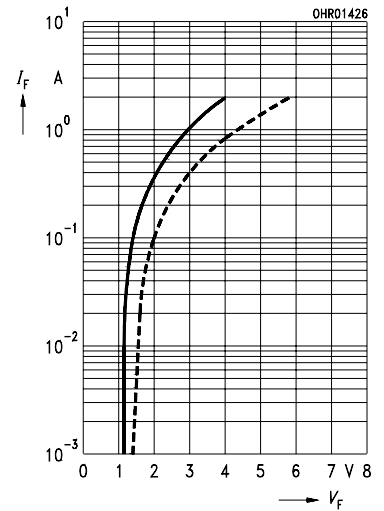

Directional Characteristics

$I_{rel} = f(\varphi)$

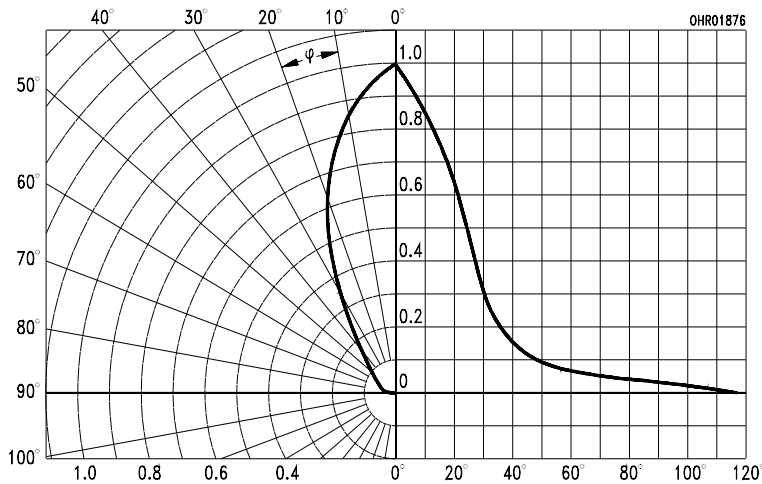

**Maßzeichnung
Package Outlines**

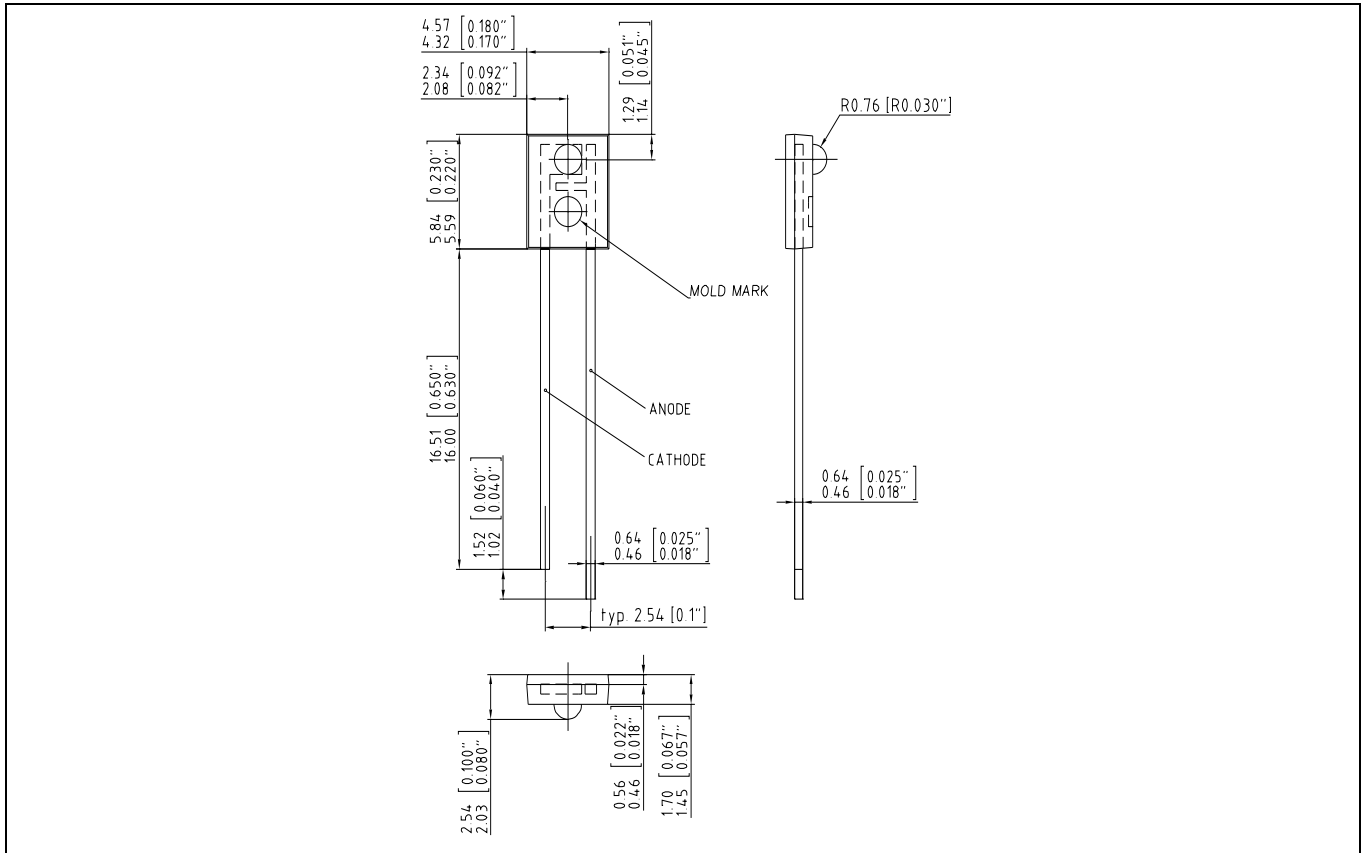

Maße in mm (inch) / Dimensions in mm (inch).

Approx. weight 0.2g

**Empfohlenes Lötpaddesign
Recommended Solder Pad**

**Wellenlöten (TTW)
TTW Soldering**

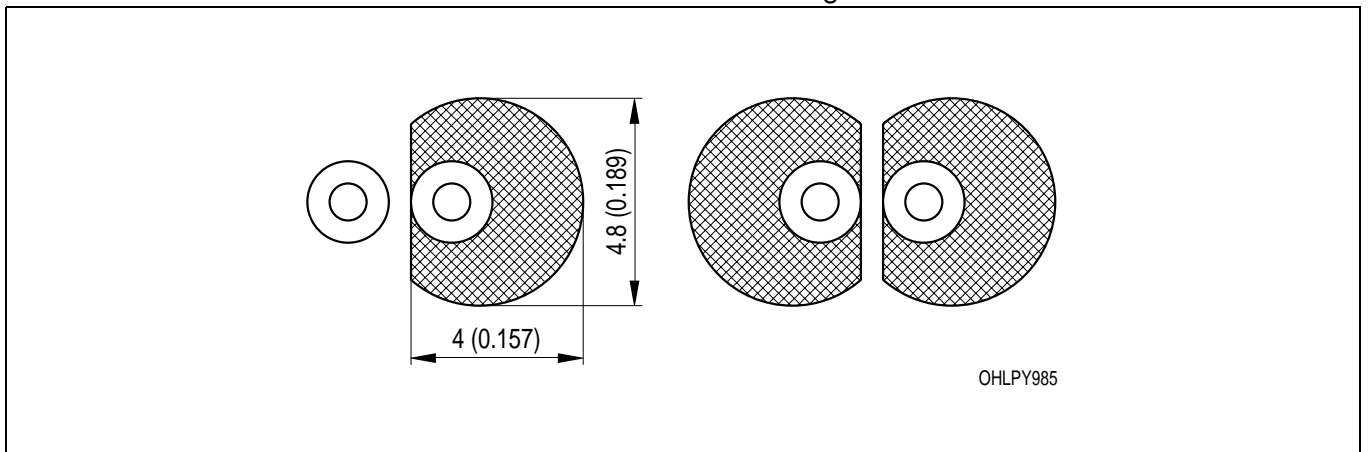

Maße in mm (inch) / Dimensions in mm (inch).

Wellenlötten (TTW)
TTW Soldering

(nach CECC 00802)
(acc. to CECC 00802)

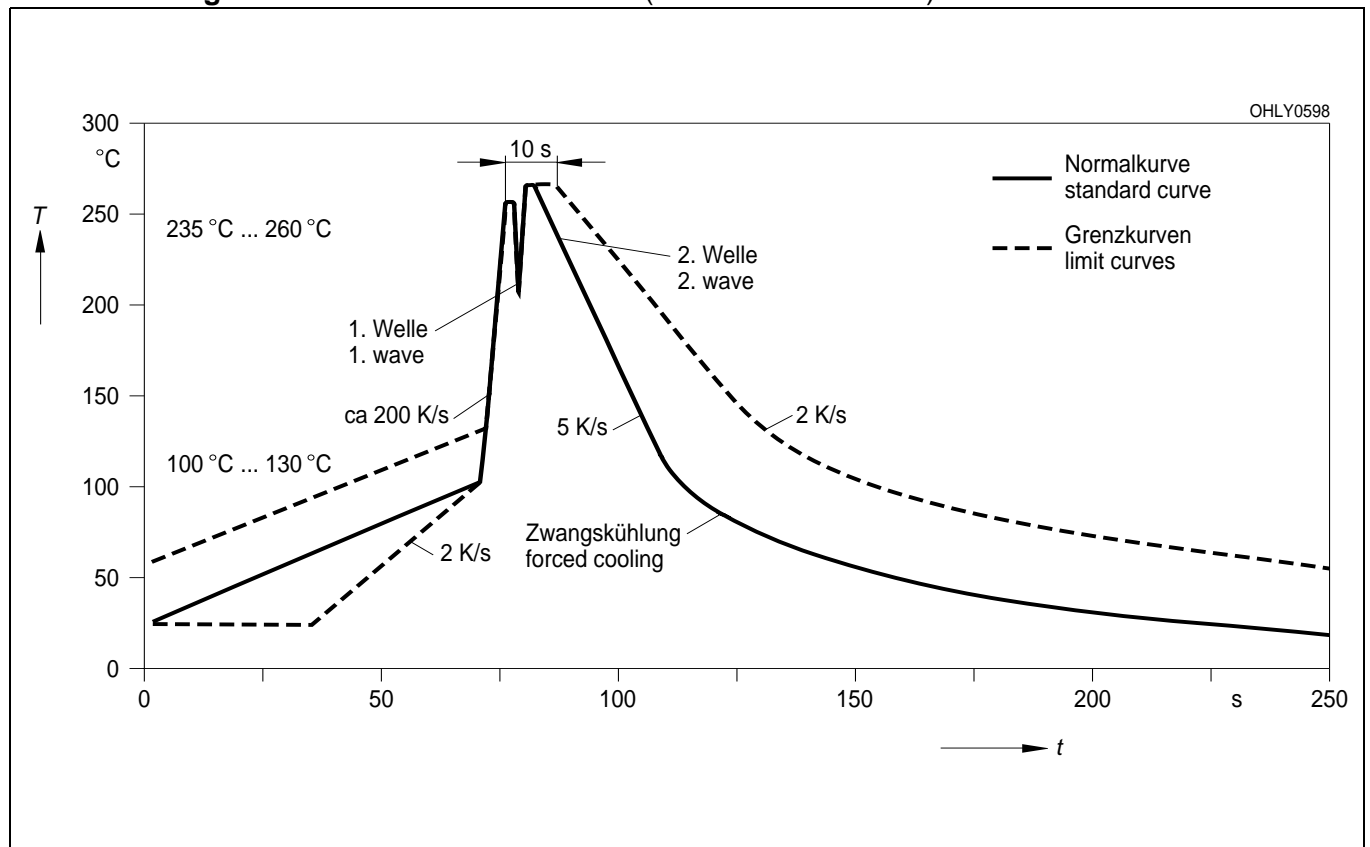

Published by
OSRAM Opto Semiconductors GmbH
Wernerwerkstrasse 2, D-93049 Regensburg
www.osram-os.com
© All Rights Reserved.

EU RoHS and China RoHS compliant product



此产品符合欧盟 RoHS 指令的要求；
按照中国的相关法规和标准，不含有毒有害物质或元素。

The information describes the type of component and shall not be considered as assured characteristics. Terms of delivery and rights to change design reserved. Due to technical requirements components may contain dangerous substances. For information on the types in question please contact our Sales Organization.

Packing

Please use the recycling operators known to you. We can also help you – get in touch with your nearest sales office. By agreement we will take packing material back, if it is sorted. You must bear the costs of transport. For packing material that is returned to us unsorted or which we are not obliged to accept, we shall have to invoice you for any costs incurred.

Components used in life-support devices or systems must be expressly authorized for such purpose! Critical components¹, may only be used in life-support devices or systems² with the express written approval of OSRAM OS.

¹ A critical component is a component used in a life-support device or system whose failure can reasonably be expected to cause the failure of that life-support device or system, or to affect its safety or effectiveness of that device or system.

² Life support devices or systems are intended (a) to be implanted in the human body, or (b) to support and/or maintain and sustain human life. If they fail, it is reasonable to assume that the health of the user may be endangered.